

# LF310 Datasheet

## LOW-FLOW PRESSURE REGULATOR



Gas  
  Liquid  
  Diaphragm  
  Piston  
  Self-Venting  
  Non-Venting  
 Max Inlet: 414 bar (6,000 psi)  
 Max Outlet: 35 bar (510 psi)  
 Cv 0.06



### INTRODUCING THE LF310...

The LF310 is a single-stage diaphragm-sensed pressure regulator for applications that require higher supply pressures in addition to an extended life cycle.

Based on the LF300, with its long-lasting Inconel® X750 diaphragm, the LF310 also offers a 'solid disk' seat design which is more robust for aggressive or high temperature applications.

### SPECIFICATION

Max. Rated Inlet Pressure	414 bar (6,000 psi)
Outlet Ranges	Up to 35 bar (510 psi)
Design Proof Pressure	150% max. working pressure
Seat Leakage	In accordance with ANSI/FCI 70-3
Weight	0.9kg (2lbs)

### STANDARD MATERIALS OF CONSTRUCTION

PART	MATERIALS
Body and Bonnet	ASTM A479 316/316L Stainless Steel (UNS S31600/S31603)
Main Valve Pin	ASTM A479 316/316L Stainless Steel
Soft Seat	PEEK™ (450G) PCTFE (Kel-F)
Valve Spring	Inconel® X750 (UNS N07750)
Diaphragm	Inconel® X750 (UNS N07750)
Handwheel	Nylon
O-Rings	FKM/FPM (Viton)
Loading Spring	ASTM A240 301 Stainless Steel (UNS S30100)
Filter	40 Microns

*Note:* Pressure regulator rating may be limited by connection type, Cv and/or seat material. Contact the office for specific pressure or temperature requirements.

### FEATURES AND BENEFITS

#### 1 INCONEL® X750 DIAPHRAGM

For ultimate strength and reliability on clean or corrosive applications.

#### 2 316SS THREADED BONNET

For panel mounting option as standard.

#### 3 40 MICRON INLET FILTER

First stage soft seat protection from system contamination.

#### 4 SOLID DISK SEAT DESIGN

Robust design enabling higher inlet pressures of up to 414 bar (6,000 psi).

Product availability and specifications contained herein are subject to change without notice. Consult local distributor or factory for potential revisions and/or service related issues. Pressure Tech Ltd support with product selection recommendations only - it is the users responsibility to ensure the product is suitable for their specific application requirements.



#### PRESSURE TECH LTD

Unit 24, Graphite Way, Hadfield, Glossop, Derbyshire, UK, SK13 1QH  
 +44 (0)1457 899 307 | [sales@pressure-tech.com](mailto:sales@pressure-tech.com) | [www.pressure-tech.com](http://www.pressure-tech.com)

DESIGNED, MANUFACTURED AND BUILT IN THE UK

© 2024 Pressure Tech Ltd. All Rights Reserved.

030225

PAGE:  
1 OF 4

# LF310 Datasheet

LOW-FLOW PRESSURE REGULATOR



Gas  
  Liquid  
  Diaphragm  
  Piston  
  Self-Venting  
  Non-Venting  
 Max Inlet: 414 bar (6,000 psi)  
 Max Outlet: 35 bar (510 psi)  
 Cv 0.06

## DRAWINGS AND INSTALLATION DIMENSIONS

Dimensions shown for 1/4" NPT option and standard configurations only - please contact the office for other options.

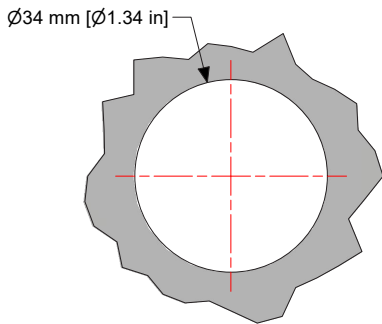
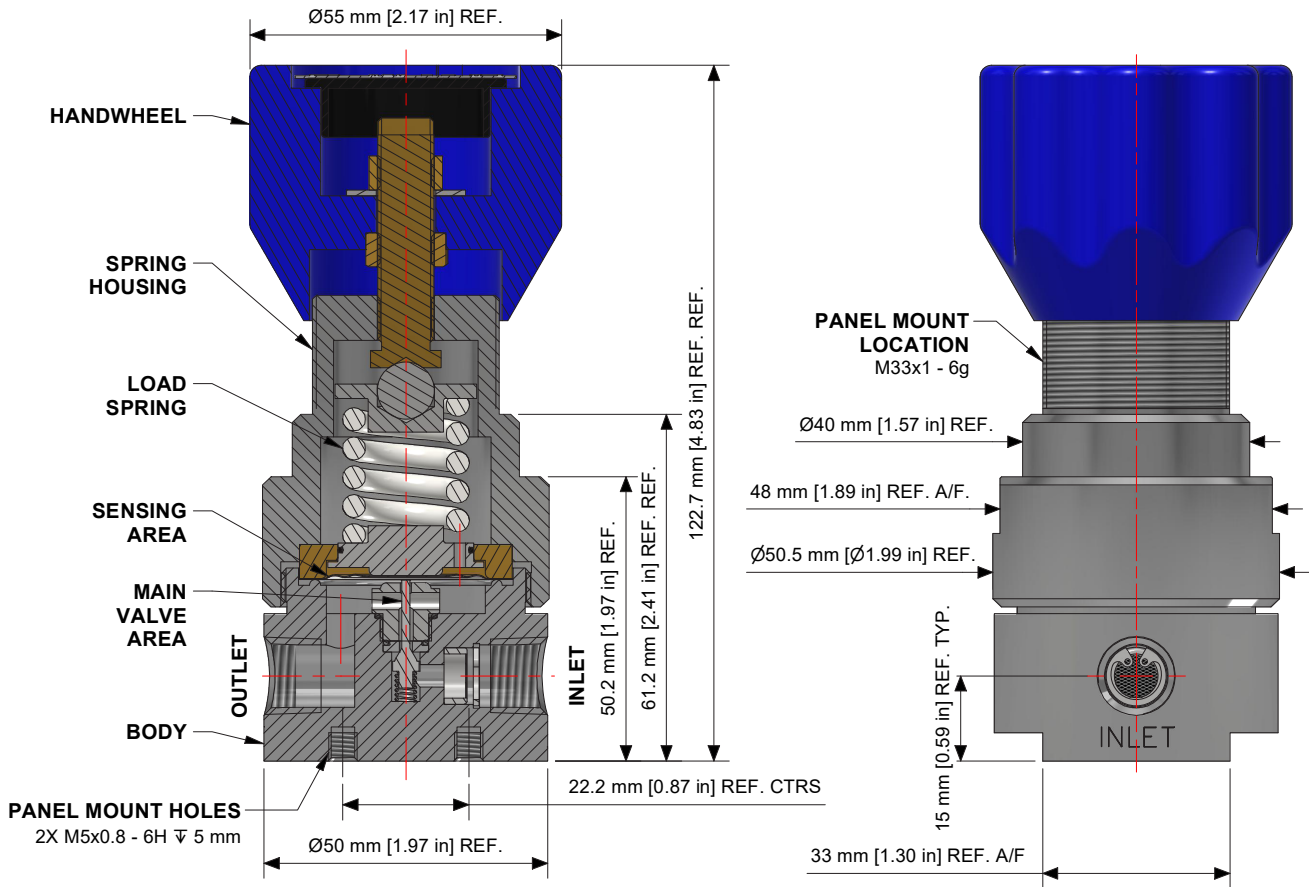

**Note:** **PANEL CUTOUT**  
All gauge ports are 1/4" NPT as standard.

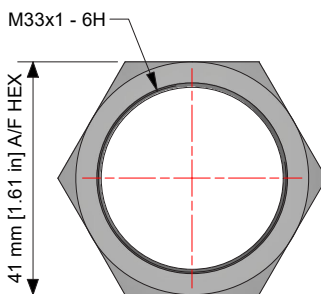

**PANEL MOUNT RING**  
(PT-C-024)  
STAINLESS STEEL

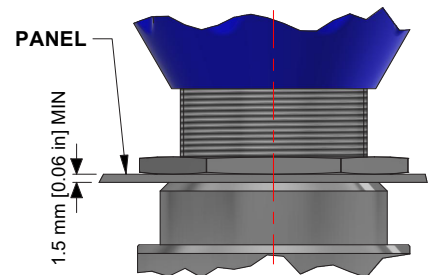

Product availability and specifications contained herein are subject to change without notice. Consult local distributor or factory for potential revisions and/or service related issues. Pressure Tech Ltd support with product selection recommendations only - it is the users responsibility to ensure the product is suitable for their specific application requirements.



**PRESSURE TECH LTD**  
 Unit 24, Graphite Way, Hadfield, Glossop, Derbyshire, UK, SK13 1QH  
 +44 (0)1457 899 307 | [sales@pressure-tech.com](mailto:sales@pressure-tech.com) | [www.pressure-tech.com](http://www.pressure-tech.com)  
**DESIGNED, MANUFACTURED AND BUILT IN THE UK**  
 © 2024 Pressure Tech Ltd. All Rights Reserved.

030225

# LF310 Datasheet

LOW-FLOW PRESSURE REGULATOR



Gas  
  Liquid  
  Diaphragm  
  Piston  
  Self-Venting  
  Non-Venting  
 Max Inlet: 414 bar (6,000 psi)  
 Max Outlet: 35 bar (510 psi)  
 Cv 0.06

## FLOW CURVE

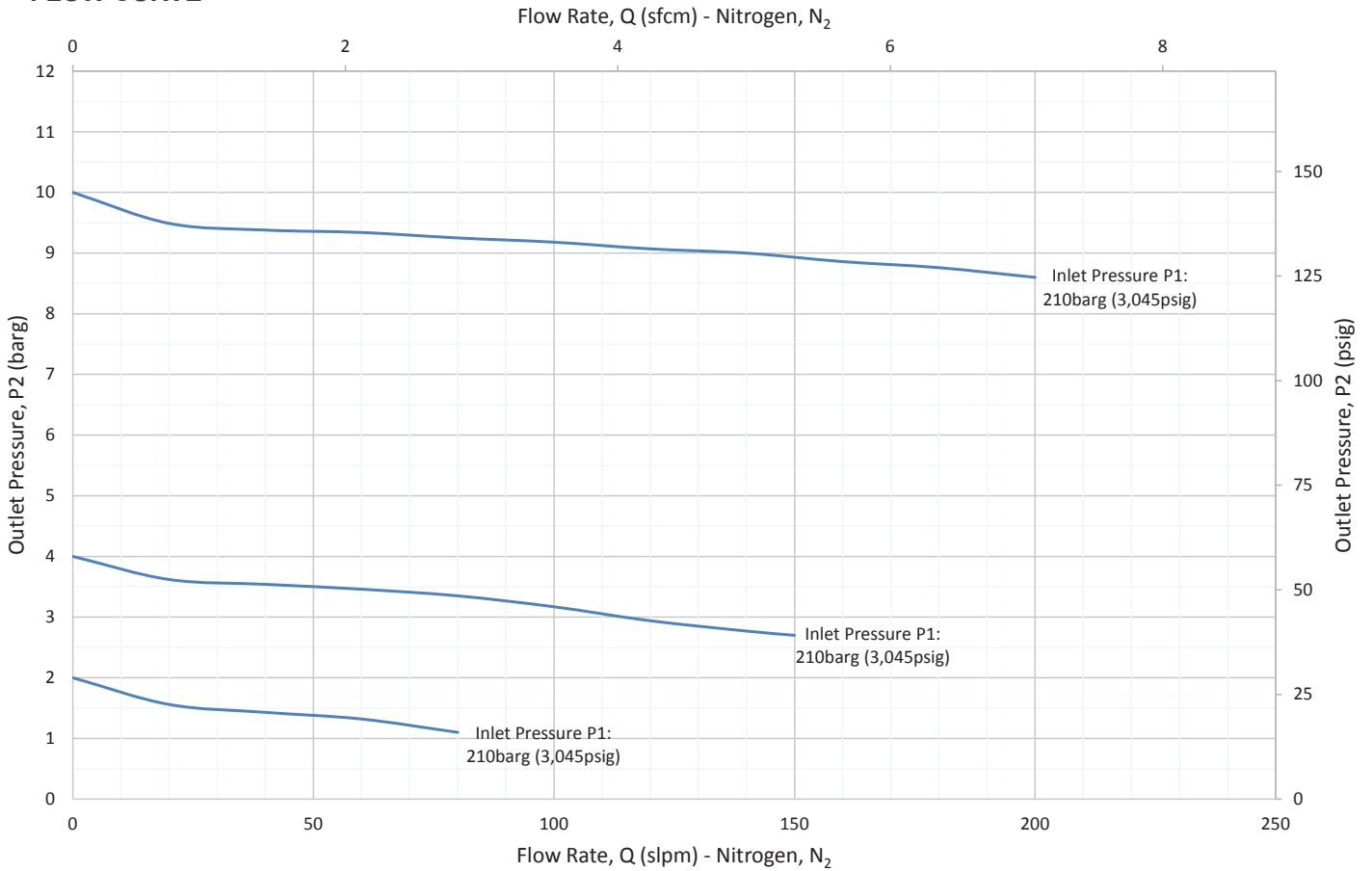

## PORTING CONFIGURATIONS

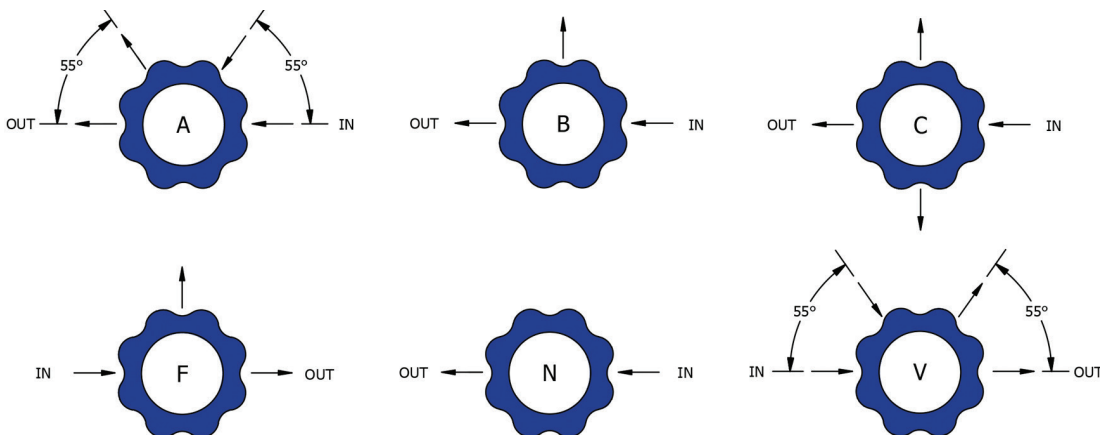

### Note:

Additional porting configurations are available - please contact the office for further information.

Product availability and specifications contained herein are subject to change without notice. Consult local distributor or factory for potential revisions and/or service related issues. Pressure Tech Ltd support with product selection recommendations only - it is the users responsibility to ensure the product is suitable for their specific application requirements.



### PRESSURE TECH LTD

Unit 24, Graphite Way, Hadfield, Glossop, Derbyshire, UK, SK13 1QH  
 +44 (0)1457 899 307 | [sales@pressure-tech.com](mailto:sales@pressure-tech.com) | [www.pressure-tech.com](http://www.pressure-tech.com)

DESIGNED, MANUFACTURED AND BUILT IN THE UK

© 2024 Pressure Tech Ltd. All Rights Reserved.

030225

PAGE:  
3 OF 4

# LF310 Datasheet

LOW-FLOW PRESSURE REGULATOR



Gas  
  Liquid  
 |  
  Diaphragm  
  Piston  
 |  
  Self-Venting  
  Non-Venting  
 |  
 Max Inlet: 414 bar (6,000 psi)  
 |  
 Max Outlet: 35 bar (510 psi)  
 |  
 Cv 0.06

## ORDERING INFORMATION

To build a Pressure Tech part number, simply combine the characters identified below in sequence:

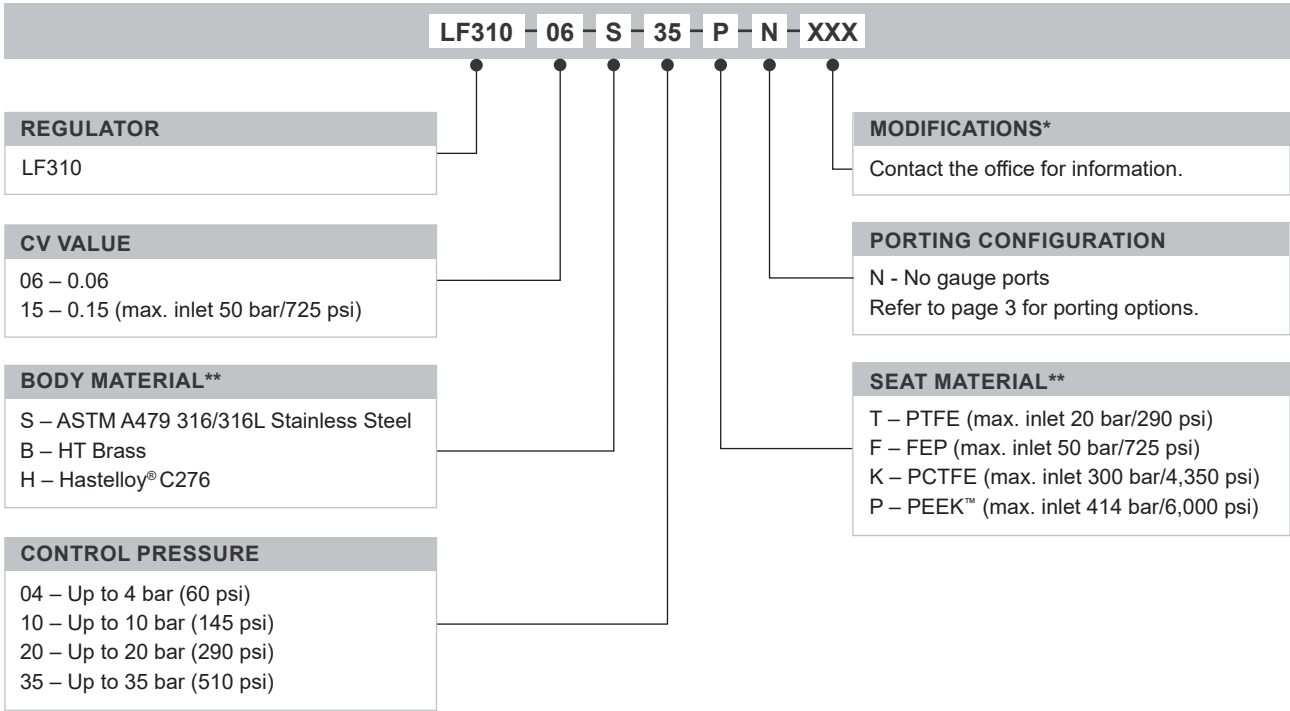

OPTIONAL EXTRAS		
	PART NUMBER	DESCRIPTION
Service Kit	SRK-LF310-06-U-K-M2-V	PCTFE seat and FKM/FPM seals
Service Kit	SRK-LF310-06-U-P-M2-V	PEEK™ seat and FKM/FPM seals
Panel Mounting Ring	PT-C-024	-

*Note:* Ancillary equipment and additional Service Kit options also available

**TRADEMARKS:** PEEK™ is a trademark of Victrex PLC  
 Inconel® is a registered trademark of Inco Alloys International  
 Hastelloy® is a registered trademark of Haynes International, Inc

\* Where applicable  
 \*\* Other materials may be available

Product availability and specifications contained herein are subject to change without notice. Consult local distributor or factory for potential revisions and/or service related issues.  
 Pressure Tech Ltd support with product selection recommendations only - it is the users responsibility to ensure the product is suitable for their specific application requirements.



**PRESSURE TECH LTD**  
 Unit 24, Graphite Way, Hadfield, Glossop, Derbyshire, UK, SK13 1QH  
 +44 (0)1457 899 307 | [sales@pressure-tech.com](mailto:sales@pressure-tech.com) | [www.pressure-tech.com](http://www.pressure-tech.com)  
**DESIGNED, MANUFACTURED AND BUILT IN THE UK**  
 © 2024 Pressure Tech Ltd. All Rights Reserved.

030225